

EvoluX™ iQ

Robotic Pool Cleaner

TYPE EC15 --

Models: EX5050 iQ
EX6050 iQ

WARNING

FOR YOUR SAFETY – For anything other than the routine cleaning and maintenance described in this guide, this product must be serviced by a qualified professional with sufficient experience in pool equipment installation and maintenance so that all of the instructions in the product's complete installation and operations manual can be followed exactly. All safety instructions in the complete manual must be followed explicitly, in order to prevent injury hazards. Improper installation and/or operation may void the warranty. Never turn the cleaner on unless it is fully submerged in the water. Doing so may void the warranty and may cause severe damage to the cleaner motors.

Table of Contents

Section 1. Important Safety Instructions	3	Section 7. Maintenance	9
Section 2. Cleaner Specifications	4	7.1 Cord Tangling.....	9
2.1 General Specifications.....	4	7.2 Clean the Filter Canisters	10
Section 3. Assembly	4	7.3 Store the Cleaner When Not in Use.....	11
3.1 Contents	4	7.4 Replacing Wear Parts	11
3.2 Attach the Control Unit to the Caddy	4	7.5 Replacing Tyres.....	12
3.3 Connect the Floating Cable.....	4	Section 8. Troubleshooting	14
Section 4. General Cleaner Operation	5	8.1 Error Codes.....	14
4.1 Install and Submerge the Cleaner	5	8.2 General Troubleshooting.....	15
4.2 Control Unit.....	6	8.3 Dismissing an Error Code.....	16
4.3 Start / Stop Cleaning and Adjust Cleaning Time.....	7	8.4 iAquaLink Troubleshooting	16
4.4 Lift System.....	7	8.5 Common iAquaLink™ Troubleshooting	17
Section 5. Installing iAquaLink™	7	8.6 Conformity	17
5.1 Download the App	7		
5.2 Sign Up and Log In.....	7		
5.3 Configure the System	7		
Section 6. iAquaLink™ Control	8		
6.1 iAquaLink™ Control Home Screen	8		
6.2 Start / Stop Cleaning and Adjust Cleaning Time.....	8		
6.3 Set Cleaning Mode	8		
6.4 Remote Control.....	8		
6.5 Lift System.....	8		
6.6 Program or Cancel Cleaning Schedules.....	9		
6.7 Temperature Display (<i>not available on all models</i>)	9		
6.8 LED Lights	9		
6.9 In-App Error Messages and Troubleshooting	9		
6.10 System Settings.....	9		

Section 1. Important Safety Instructions

READ AND FOLLOW ALL INSTRUCTIONS

Congratulations on purchasing the Zodiac Robotic Cleaner. Please read through the entire manual before installing your new robotic pool cleaner. Your cleaner must be installed and operated as specified.

WARNING

Failure to comply with the following warnings can increase risk of fire or electrocution which can result in property damage and serious injury, including loss of life.

PREVENT ELECTRICAL SHOCK

To reduce risk of electrical shock:

- The cleaner is to be installed in accordance with the relevant requirements of the Australian wiring rules AS/NZS 3000. Also refer to the installation instructions relating to the swimming pool equipment for which the cleaner will be an integral part. The cleaner is to be supplied through a Residual Current Device (RCD) with a rated residual operating current of 30mA.
- Do not enter pool while the robotic cleaner is in water.
- Do not bury cord. Locate cord so as to prevent it from being damaged by lawn mowers, hedge trimmers and other equipment.
- To reduce the risk of electrical shock, do not use the robotic cleaner or control unit if the cord is worn or damaged. Contact Zodiac Customer Care Service 1300 763 021 immediately for proper servicing and replacement of the damaged cord.
- Double insulation—For continued protection against possible electric shock, use only identical replacement parts when servicing. Do not attempt repair of the robotic cleaner, control unit, power cord, or floating cable.
- Use only the power supply provided with the product.
- NEVER OPEN CONTROL UNIT.
- DO NOT USE AN EXTENSION CORD TO CONNECT THE UNIT TO ELECTRIC SUPPLY; PROVIDE A PROPERLY LOCATED APPROVED ELECTRICAL OUTLET. THE CONTROL UNIT SHOULD BE PLACED NEAR THE APPROVED RECEPTACLE BOX.

PREVENT CHILD INJURY AND DROWNING

- To reduce the risk of injury, do not permit children or persons with reduced physical, sensory or mental capabilities, or lack of experience and knowledge to operate this product.
- Do not let anyone, especially small children, sit, step, lean, or climb on any equipment installed as part of your pool's operational system.

CAUTION

Failure to comply with the following warnings could cause damage to pool equipment or personal injury.

- The robotic cleaner must be installed and operated as specified.
- This product is intended for use with permanently-installed pools. Do not use with storable pools. A permanently-installed pool is constructed in or on the ground or in a building such that it cannot be readily disassembled for storage. A storable pool is constructed so that it is capable of being readily disassembled for storage and reassembled to its original integrity.
- Clean the filter canister in the Evolux cleaner after each use.
- Do not use the product in your pool if the water temperature is above 35° C (95° F) or below 13° C (55° F).

USE OF THE ZODIAC ROBOTIC CLEANER IN A VINYL LINER POOL

Certain vinyl liner patterns are particularly susceptible to rapid surface wear of pattern removal caused by objects coming into contact with the vinyl surface, including pool brushes, pool toys, floats, fountains, chlorine dispensers, and automatic pool cleaners. Some vinyl liner patterns can be seriously scratched or abraded simply by rubbing the surface with a pool brush. Ink from the pattern can also rub off during the installation process or when it comes into contact with objects in the pool. Fluidra Group Australia Pty. Ltd. is not responsible for, and the Limited Warranty does not cover, pattern removal, abrasion or markings on vinyl liners.

SAVE THESE INSTRUCTIONS

Section 2. Cleaner Specifications

2.1 General Specifications

The general specifications for the cleaner are as follows:

Control box supply voltage	 220-240 VAC, 50 Hz; short circuit-proof safety isolating type
Supply voltage	30 V DC
Installed load	150 W max
Cable length	18 m or 21 m depending on model
Cleaner size (WxDxH)	43 x 48 x 27 cm
Weight of Cleaner	9.5 kg
Packed weight	19 kg
Filtration	Dual Stage Filter Canister
Cycle lengths	18 min or 21 min depending on model

The cleaner is a double-insulated product. A double-insulated electrical appliance is one which has been designed in such a way that it does not require a safety connection to ground. The basic requirement for double-insulation is that no single failure can result in dangerous voltage becoming exposed so that it might cause an electric shock and that this is achieved without relying on an earthed (grounded) metal casing. This is achieved by having two (2) layers of insulating material surrounding live parts or by using reinforced insulation. Therefore, devices having double-insulated construction, such as this cleaner, do not utilize a grounded (three-prong) cord/plug.

Section 3. Assembly

3.1 Contents

The packaging should contain the following items:

- Cleaner and floating cable with swivel
- Control unit
- Printed materials
- Transport and Storage Caddy components

When unpacking the cleaner and its components:

- Check to make sure each component is in the box.
- Check cleaner and components for damage during transport.
- If there are any missing parts or damage, contact Technical Support at 1300 763 021 for Australia or 0800 807 665 for New Zealand.

3.2 Attach the Control Unit to the Caddy

1. Align the bottom of the control unit with the notch at bottom of the control unit hook on the caddy (Figure 1).

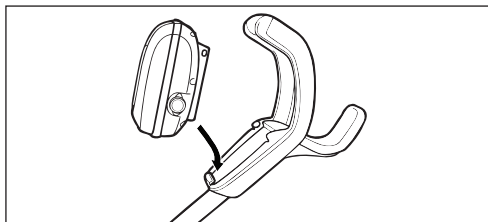

Figure 1. Align Control Unit with Caddy Hook

2. Press control unit onto the caddy hook until it snaps and locks into position (Figure 2).

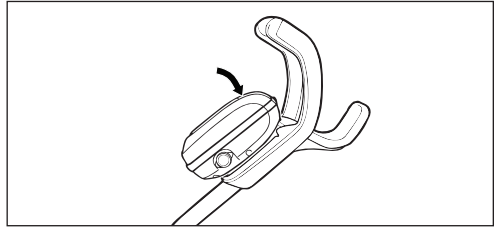

Figure 2. Attach the Control Unit onto Caddy

3.3 Connect the Floating Cable

WARNING

Never turn on the cleaner unless it is fully submerged in the water. Doing so will void the warranty and may cause severe damage to the cleaner motors.

Do not use an extension cord to connect the control unit.

1. Unscrew the protective cap for the floating cable from the side of the control unit by turning counter-clockwise.
2. Grip the notched end of the floating power cable, insert into the control unit, and turn clockwise to tighten (Figure 3).

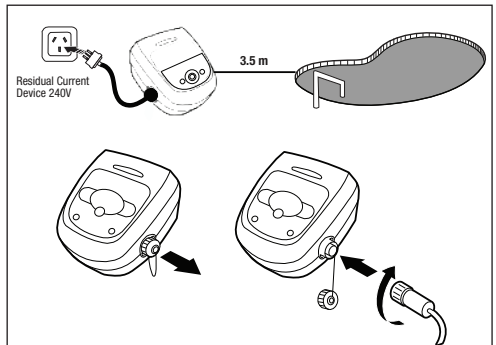

Figure 3. Connect/Disconnect the Floating Cable

Section 4. General Cleaner Operation

⚠ CAUTION

To prevent damage to the cleaner, be sure to adhere to the following guidelines:

- Remove the cleaner from the pool after the cleaning cycle is completed.
- Store on the caddy out of direct sunlight or inclement weather.
- Never lift the cleaner out of the pool by the floating cable. Always use the lift feature to remove cleaner from the pool.
- Take additional care when lifting the cleaner out of the pool. It becomes heavier when filled with water.
- Always remove the cleaner from pool when super chlorinating or adding acid.
- Do not handle cleaner while it is in operation

IMPORTANT

- Always make sure the cleaner head is fully submerged before you begin operation.
- Clean the filter canister after each cleaning cycle.
- Do not leave your cleaner in the pool on a permanent basis.
- At the end of each cycle, remove the cleaner from the pool.
- Start at the cleaner head and untangle any coils in the cable before storing the cleaner.

The Zodiac EvoluX iQ robotic cleaner includes a safety feature that automatically stops the cleaner if it is powered on but not submerged in water. For pools equipped with a beach area, this safety feature is programmed to drive the cleaner in reverse and back into the pool when the impeller is out of the water.

Zodiac recommends not exceeding three (3) cleaning cycles per week.

4.1 Install and Submerge the Cleaner

1. With the control box plugged into a power outlet, spread the floating cable across the pool deck until you reach the middle of the pool length.
2. At the center point, submerge the cleaner in the pool and hold in the vertical position to release any air trapped inside. (Figure 4).

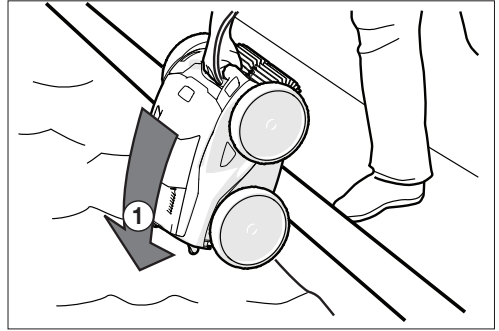

Figure 4. Submerge the Cleaner Vertically

3. Ensure the unit sinks to the bottom of the pool and does not float (Figure 5).

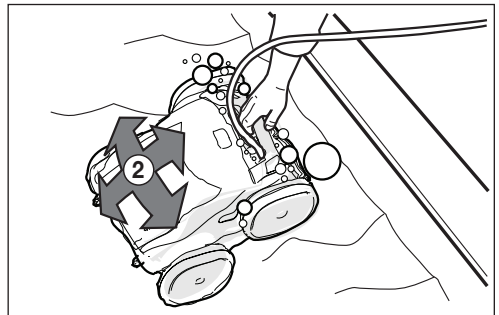

Figure 5. Cleaner Sinking to the Bottom of the Pool

4. Place only enough floating cable in the water to reach the farthest end of your pool from the central point. Spread out the floating cable ensuring there are no kinks or coils in the cable (Figure 6).

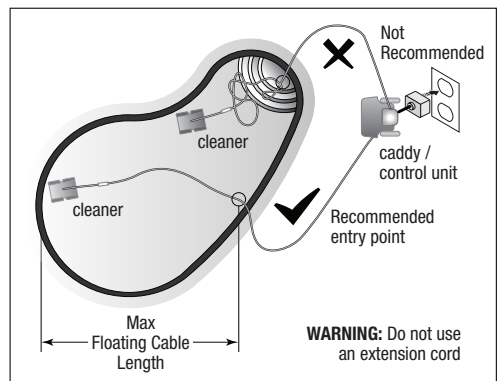
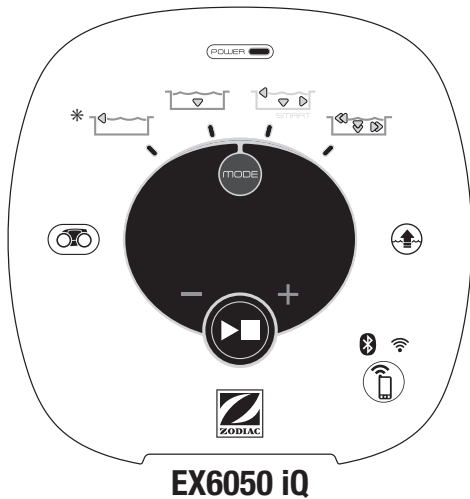
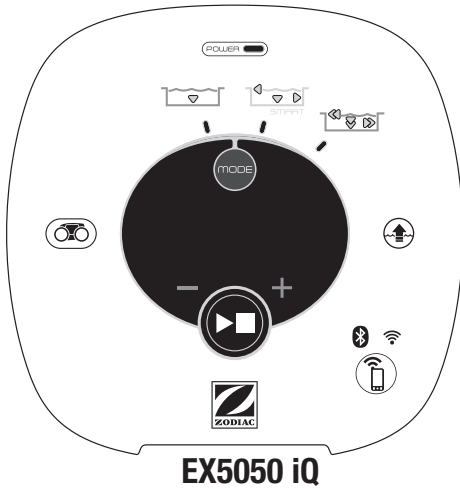

Figure 6. Pool Entry Point for Optimal Patterning

4.2 Control Unit

The control unit can be used to initiate basic cleaning features and to connect the device to home Wi-Fi. For more information on connecting your cleaner to Wi-Fi, see section 5, Installing iAquaLink™.



Button Functions	
	Control unit is receiving power
	Start/Stop cleaning
	Select cleaning mode
	Waterline only (45 min)
	* Quick Clean (1h 15 min) Floor only
	SMART Cycle (Calculate custom clean duration) Floor, Wall, Waterline
	Deep Clean (2h 45 min) Floor, Walls, Waterline, High Intensity
	Dirty canister indicator
	Remove cleaner from the pool
	+ / - 15 minute increments
	Initiate connection and set up iAquaLink™ control
	Bluetooth® connection status: <i>BLINKING</i> - searching for signal <i>SOLID</i> - paired with phone
	Wi-Fi connection status: <i>BLINKING</i> - connected to router <i>SOLID</i> - connected to the internet

* Available on EX6050 iQ model only.

4.3 Start / Stop Cleaning and Adjust Cleaning Time





The factory default cleaning mode is SMART Cycle (Floor, Wall, Waterline).

Cycle calculates a customized cleaning time optimized for your pool. On the first run of SMART Cycle, the control box counts up from zero as it calculates the optimized cleaning time.

On periodic SMART Cycle cleaning, the control box will count down from the optimized cleaning time.

1. To recalculate the SMART Cycle setting, press and hold the  button for 5 seconds.

2. Use  to change cleaning surface setting. Toggle between:

- *  Waterline Only (45 min)
-  Quick Clean (1h 15 min) Floor only
-  SMART Cycle (calculates custom cleaning duration) Floor, Wall, Waterline
-  Deep Clean (2h 45 min) Floor, Walls, Waterline, High Intensity

*Available on EX6050 iQ only.

3. With the cleaner submerged in the water, press  to begin operation.
4. Press again to interrupt and cancel an in-progress cleaning cycle.

NOTE: The control box automatically goes into standby mode after 5 minutes and the display screen turns off. Press any key to exit standby mode and view remaining cycle time. Cleaner will continue to function in standby mode.

5. Press +/- buttons to increase or decrease cleaning time in 15-minute increments.
 - Minimum run time is 30 minutes
 - Maximum run time is 3 hours 30 minutes

4.4 Lift System

The Lift System is designed to assist in retrieving the robot from the pool. Lift System can be activated at any time during or after a cleaning cycle.

1. Press  to begin the automated procedure. The screen displays **LIFE** when the Lift System is in operation.

NOTE: To stop the procedure at any time, press and release the button again.

2. Next, Press and HOLD  to rotate the cleaner.
3. Once the cleaner is facing the wall of your choice for retrieval, release the button.
4. Cleaner will drive forward and up the wall it is facing. It will wait at the water line to be retrieved.

5. When in reach, remove the cleaner from the pool using the handle. The cleaner will quickly expel water to allow for lighter, easier removal.

NOTE: Never lift the cleaner out of the pool by the floating cable.

Section 5. Installing iAquaLink™



The iAquaLink app is available for download from the App Store or Google Play.

With iAquaLink Control, you can connect to your robotic cleaner from anywhere, anytime to access many functions and troubleshooting advice. App features are dependant on model.

Before you begin installation, make sure you have the following:

- Robotic Cleaner submerged in the pool.
- Control Box connected and plugged into a GFCI outlet.
- Smart device (phone or tablet) with Wi-Fi and Bluetooth enabled
- Wi-Fi router with sufficient signal strength at the Control Box
- **IMPORTANT:** Have your Wi-Fi network password available.

5.1 Download the App

Install or update the **iAquaLink app** from the App Store or Google Play.





Once the download is complete, select the **iAquaLink icon** on your smart device to open the app.

5.2 Sign Up and Log In

Open the iAquaLink app, then **Sign Up** or **Log In**.

Complete all required fields in the Account Set Up page and agree to the Terms and Conditions.

5.3 Configure the System

1. On the My Systems page, click + in the upper right-hand corner to add a system.
2. Choose "Robotic Cleaner" from the list and choose your model type.
3. On the Control Box, press  
 - Bluetooth light  indicates status:
 - BLINKING* - searching for signal
 - SOLID* - paired with phone
4. Follow on-screen prompts to add your cleaner and connect to your home router.
 - Wi-Fi light  indicates status:
 - BLINKING* - connected to router
 - SOLID* - connected to the internet

NOTE: The searching screen may take a few minutes to find your router. If you receive an error you may have a weak router signal at the location of your control box OR you may have entered an incorrect Wi-Fi password. In the case of a weak router signal, consider installing a Wi-Fi extender to boost your signal strength. (See iAquaLink Troubleshooting section.)

Section 6. iAquaLink™ Control

Once you have downloaded the iAquaLink app and connected the device to Wi-Fi, the iAquaLink app allows for robotic cleaner control from anywhere, anytime.

Functions vary within the iAqualink app depending on which cleaner model you have.



6.1 iAquaLink™ Control Home Screen

App function and design is subject to change.

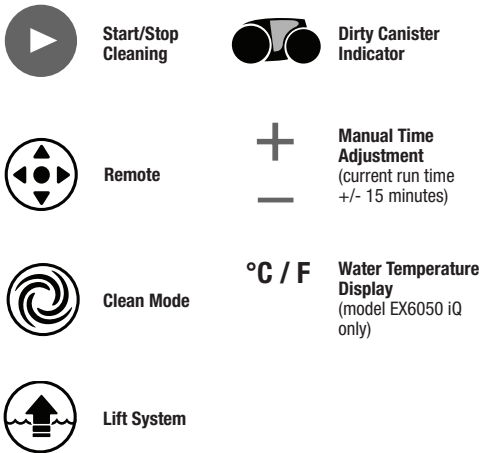

6.2 Start / Stop Cleaning and Adjust Cleaning Time

The factory default cleaning surface setting is SMART Cycle (Floor, Wall, Waterline).

SMART Cycle calculates a customized cleaning time optimized for your pool. On the first run of SMART Cycle, the app counts up as it calculates the optimized cleaning time.

On periodic SMART Cycle cleaning, the app will count down from the optimized cleaning time.

NOTE: To recalculate SMART Cycle, go to the Set Cleaning Mode after the initial calculation.

- From the Home screen or the Control Box, press the Start/Stop button to begin cleaning. 
- The app displays the cycle time in hours and minutes.
To increase or decrease the cycle time during cleaning, press the (+) and (-) buttons.
 - Time adjusts up or down in 15 minute increments.
 - Minimum run time is 30 minutes.
 - Maximum run time is 3 hours 30 minutes.

- The control box displays the same countdown and cycle setting as the app.

- Press  to interrupt and cancel an in-progress cleaning cycle.

6.3 Set Cleaning Mode

- From the main screen, select **Cleaning Mode** to view options.
- Choose from available cleaning modes depending on your cleaner model.
- In Custom mode (if applicable*), select the cleaning surface and cleaning intensity from the on-screen icons.
* not available on all models

6.4 Remote Control

Use your mobile device as a remote control.

IMPORTANT: Only use Remote Control when in view of the cleaner.

- From the main screen, select the Remote tab.

NOTE: When in remote control mode, the control box displays.



- You can direct the cleaner using the remote control or use the spot clean feature (not available on all models) to help pick up debris.

*3. To use Spot Clean, drive the cleaner near where debris has collected and initiate "Spot Clean". The cleaner will perform a short cleaning pattern to remove debris in that area.

* not available on all models

NOTE: If you notice significant delays in response time, check your Wi-Fi connection status and signal strength.

6.5 Lift System

The Lift System is designed to assist in retrieving the robot from the pool. Lift System can be activated at any time during or after a cleaning cycle.

IMPORTANT: Only use Lift System when in view of the cleaner.

- From the main screen, select  **Lift System** to enter automated procedure.
- Use the **left** and **right** arrow icons to rotate the cleaner to face the wall of your choice.
- Press the **Lift System** icon to drive the cleaner up the wall it is facing. The cleaner will wait at the water line to be retrieved.

NOTE: To stop the procedure at any time, press and release the button again.

- When in reach, grab the cleaner handle and begin to pull cleaner out of the water. The cleaner will quickly expel water to allow for lighter, easier removal.

NOTE: Never lift the cleaner out of the pool by the floating cable.

6.6 Program or Cancel Cleaning Schedules

It is still recommended to remove and clean the filter canister after every cleaning cycle.

1. Tap the area titled **Next Cleaning** or go to **System Settings**  and choose **Schedules**.
2. To program a schedule, select the **day of the week**.
3. Select a **start time** to begin the cleaning cycle.
4. Select a cleaning mode. Mode selected will determine runtime.
5. Press **OK** to save the schedule or **Delete** to remove permanently.
6. Repeat steps 2-4 to program additional days.

NOTE: Only one programmed cleaning cycle can be scheduled per day.

7. Press **BACK** or **DONE** to leave the Edit Schedule page and return to the main screen.
8. The next scheduled cleaning cycle will display near the top of the main screen.

6.7 Temperature Display (not available on all models)

On some models, the pool water temperature will be displayed on the main app screen. Accurate temperature may take a few minutes to display as the sensor acclimates to the surrounding water temperature. Temperature will only be displayed during an in-progress cleaning cycle.

6.8 LED Lights

The Sensor Nav System™ LED is located on the front of the cleaner. This light indicates status, either:

- Blinking Blue - Sensing, Scanning and Cleaning
- Solid Blue - Cleaning
- Blinking Green - Lift System or Spot Cleaning
- Solid Green - Remote Control

An LED light illuminates the interior area of the body and canister.

NOTE: LED lights may be difficult to see in sunlight.

6.9 In-App Error Messages and Troubleshooting

If an error occurs, the status bar will show a warning symbol and: "Cleaning Interrupted".

1. Click on the warning symbol to view troubleshooting advice on how to fix the issue.
2. Choose **Clear Error** if you believe you have fixed the problem and want to re-try. Choose **OK** if you want to suspend the cleaner in error mode and work on the troubleshooting fix at a later time.

6.10 System Settings

Access System Settings by pressing the gear icon in the upper right hand corner of the app screen.

Section 7. Maintenance

WARNING

To avoid electric shock and other hazards which could result in permanent injury or death, disconnect (unplug) the cleaner from the power source before performing any cleaning and maintenance.

7.1 Cord Tangling

Tangling can occur more frequently when the cleaner is not attended to after each cleaning cycle. The tangle-reducing swivel, in addition to proper installation, general maintenance and the following troubleshooting steps can help to avoid cable challenges.

IMPORTANT

Cleaner power cable may become tangled if correct procedure is not followed after each cleaning cycle.

NOTE: For optimal patterning and reduced tangling, the floating cable should enter the water near the middle of the pool length. Only place enough cable in the water to reach the farthest point in the pool. See Figure 7.

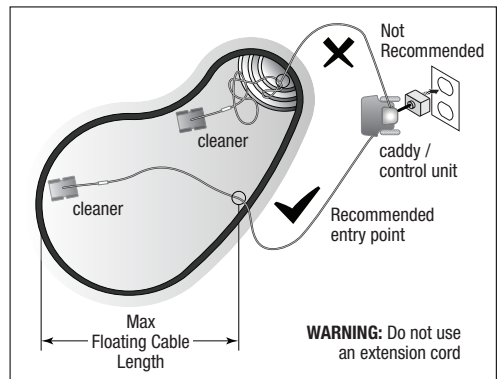

Figure 7. Optimal Entry Point in Pool

If tangling occurs, follow these steps:

1. Remove the cleaner from the pool using the Lift System. When the cleaner is within arm's reach, use the handle to remove from the water. Never lift the cleaner out of the pool by the floating cable or swivel.
2. Hold the cleaner vertically to drain. See Figure 8.

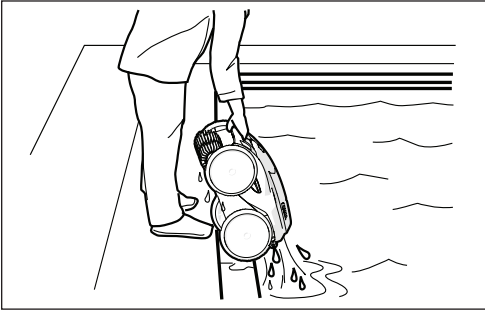

Figure 8. Keep Cleaner Vertical to Drain Water

3. Unplug power to the cleaner at the control box. See Figure 9.

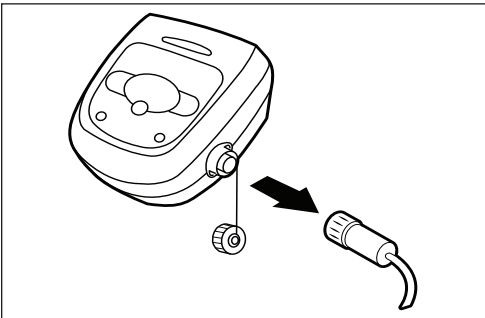

Figure 9. Unplug the Floating Cable

4. Remove the cleaner from the pool and untangle all kinks and coils in the power cable. Start at the cleaner head. Lay the cable in the sun to loosen any tangling memory. See Figure 10.

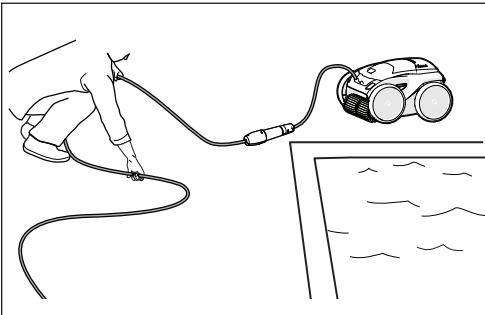

Figure 10. Untangle the Floating Cable

7.2 Clean the Filter Canisters

The filter canisters should be cleaned at the end of each cycle.

1. Remove the cleaner from the water using the Lift System and let the remaining water drain.
2. Set the unit on four wheels.
3. Push the cover lock (1) and lift the cover (2) until it is secured in the vertical position. See Figure 11.

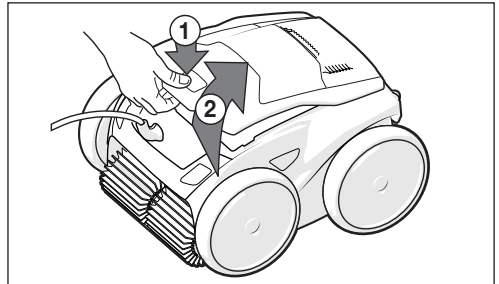

Figure 11. Lift Cleaner Cover

4. Remove the filter canister assembly from the cleaner body and separate the two canisters. See Figure 12.

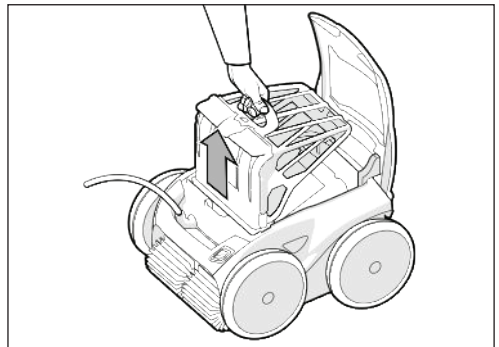

Figure 12. Remove Filter Canister Assembly

5. Push the quick release button on the canister assembly and pull open. See Figure 13,

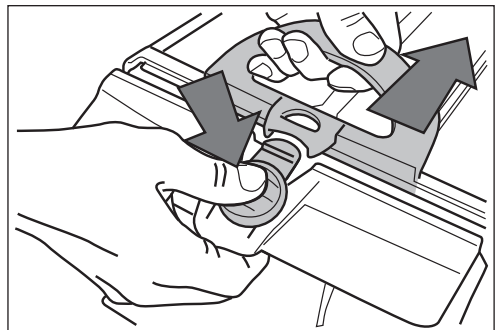

Figure 13. Open Filter Canister Assembly

6. Separate the filter canister from the filter support. See Figure 14.

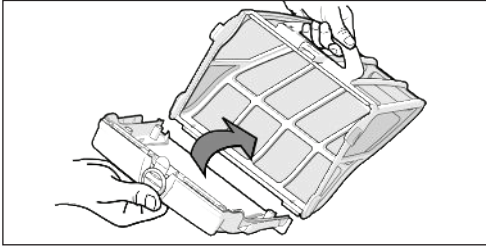

Figure 14. Separate Vanister from Support

7. Remove the filter canister. See Figure 15.

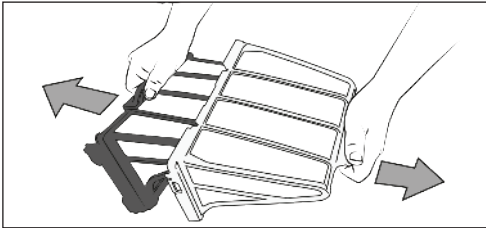

Figure 15. Remove Filter Canister

8. Empty all debris from the filter canister, then rinse the canister, the filter support and the cleaner using a hose. See Figure 16.

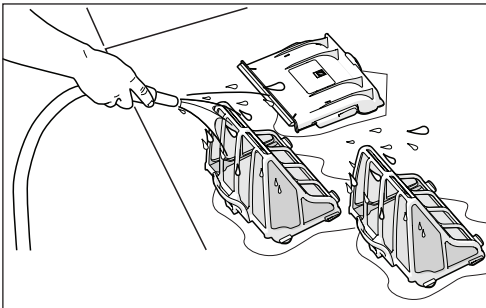

Figure 16. Wash Filter Canister

NOTE: Periodically, remove the filter canisters and clean thoroughly with soapy water and a soft bristle brush.

7.3 Store the Cleaner When Not in Use

The cleaner should be cleaned regularly using slightly soapy clean water. Do not use solvents such as trichlorethylene or its equivalent. Rinse the cleaner generously using clean water. Do not let your cleaner dry in direct sunlight near the pool. The cleaner should be stored on its caddy so that it dries quickly.

1. Disconnect cleaner from the power source.
2. Starting at the cleaner head, remove all coils and tangles from the cable. Lay the cable in the sun to loosen any tangling memory.
3. Place the rear wheels on the caddy and position the cleaner vertically on the caddy base.
4. Disconnect the cable from the control box. Replace the protective cap on the control box.
5. Loosely coil the power cable starting at the cleaner and moving toward the connection point at control box. Store the cable by wrapping it around the hook located on the front of the caddy.

7.4 Replacing Wear Parts

Replacing Brushes

The cleaner is fitted with PVC brushes with a “wear” indicator. See Figure 17.

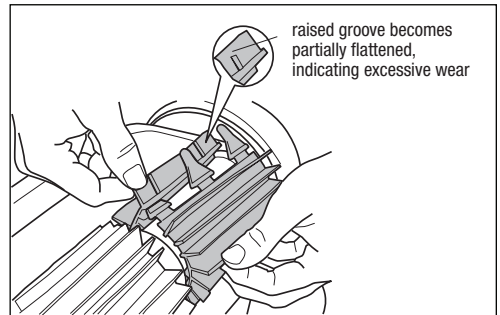

Figure 17. Worn Brush Indicator

To maintain cleaner performance at its best you need to replace the brushes as soon as one of the wear indicators is reached (even if the blade wear is not even). It is recommended that you replace the brushes when the rubber is worn down to the top of the wear indicator (or every two years, whichever comes first).

To replace a worn brush:

1. Lift the cleaner to a vertical position so that the handle is up. See Figure 18.

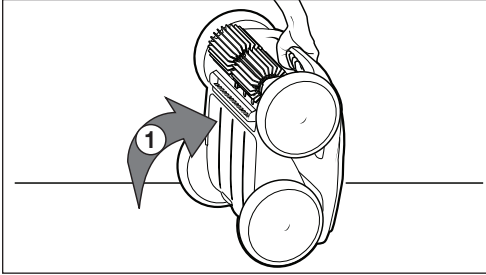

Figure 18. Cleaner in Upright Position

2. Separate the edges of the brush and undo the tabs. Remove the worn brushes. See Figure 19.

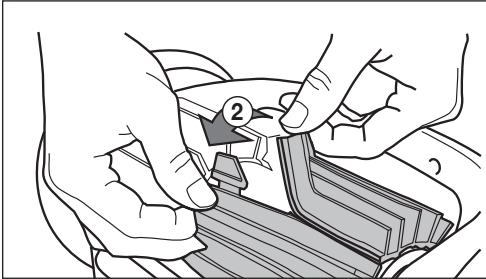

Figure 19. Undo the Tabs of the Brush

3. To install the new brush, position the new brush on the roller with the cleaning blades facing away from the roller. See Figure 20.

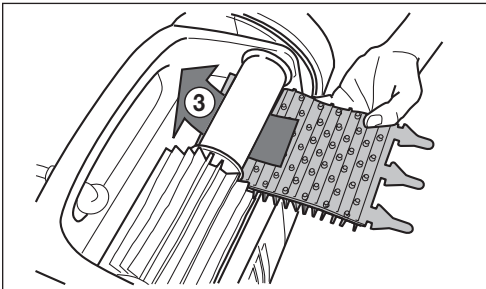

Figure 20. Install the New Brush

4. Thread each tab into the slot provided and gently feed it through until the heel comes out at the other side of the slot. See Figure 21.

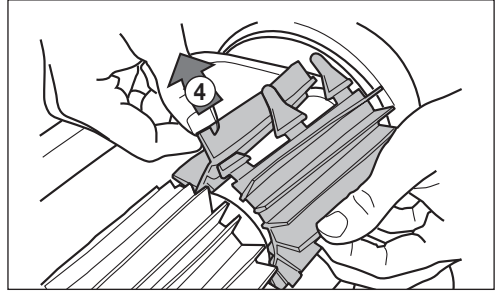

Figure 21. Pull Tabs Through Each Slot

5. Use a pair of scissors to cut the tabs 3/4 inch from the heel so that they are no higher than the cleaning blade. See Figure 22.
6. Repeat the procedure to install the second brush.

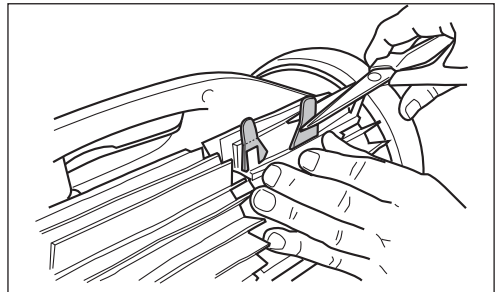

Figure 22. Cut Tabs

7.5 Replacing Tyres

1. Pull on the inside of the old tyre to remove the tyre lip from the wheel. See Figure 23.

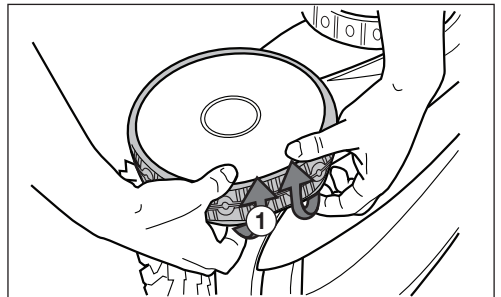

Figure 23. Pull the Old Tyre Over the Wheel

2. Remove the old tyre. See Figure 24,

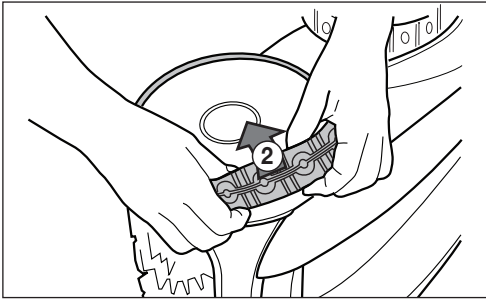

Figure 24. Remove the Old Tyre

3. To replace the tyre, position the tyre on the wheel making sure to orient the tyre so that the word **INSIDE** is toward the body of the cleaner. See Figure 25.

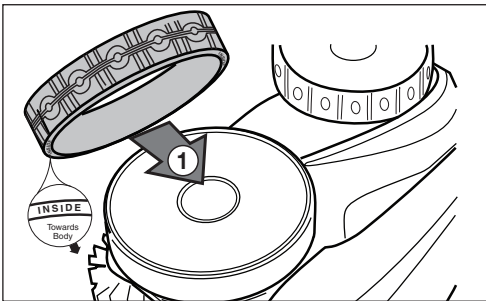

Figure 25. Tyre Replacement Orientation

4. Push one side of the tyre on to the wheel and fit the rib of the tyre in the groove of the wheel. See Figure 26.

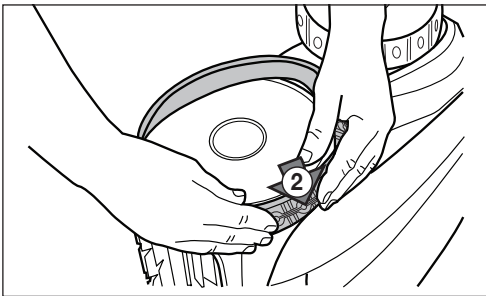

Figure 26. Start on One Side of the Tyre

5. Work the tyre onto the wheel and verify the rib of the tyre is positioned properly within the groove of the wheel. See Figure 27.

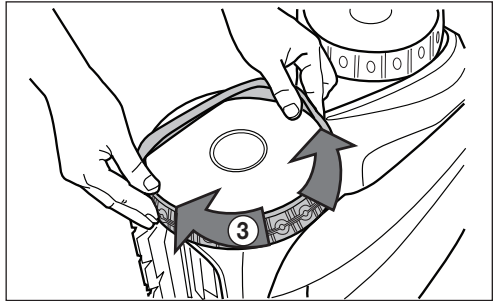

Figure 27. Work the Tyre On Around the Wheel

6. Push and position the rib of the inner side of the tyre in the groove of the wheel. If needed, turn the wheel gently to help with installation. See Figure 28.

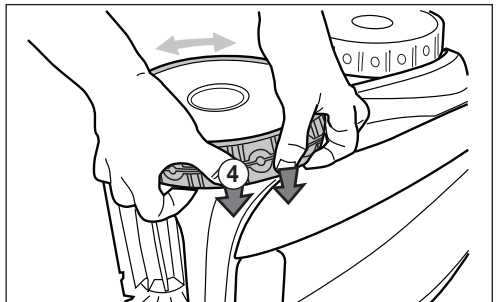

Figure 28. Push the Tyre into Place on the Wheel

Section 8. Troubleshooting

Information about the cleaner status and any relevant condition will be displayed on the control unit and/or in the iAquaLink™ app.

8.1 Error Codes

Control Unit Display	In-App Display	Suggested Solution
1	Pump Motor	a. Check for corrosion or bent pins in the floating cable connection area.
2	Traction Motor Right	b. Turn each wheel one quarter turn in one direction repeatedly until rotation is smooth. Repeat, turning wheels in the opposite direction until rotation is smooth.
3	Traction Motor Left	c. If this does not resolve the problem, contact your local retailer for a diagnostic review or call customer service.
4	Pump Motor Consumption	a. Check for small debris or hair in the fan impeller. b. Thoroughly clean the filter canister. c. If this does not resolve the problem, contact your local retailer for a diagnostic review or call customer service.
5	Drive Motor Consumption Right	a. Thoroughly clean the filter canister.
6	Drive Motor Consumption Left	b. Turn off the cleaner and submerge. Shake to release air bubbles. Restart cycle. c. If this does not resolve the problem, contact your local retailer for a diagnostic review or call customer service.
7	Cleaner Floating	• Turn cleaner power off, then submerge cleaner according to correct procedure.
8	Cleaner Out of the Water	• Turn off the cleaner and submerge. Shake to release air bubbles. Restart cycle.
9	N/A	• Cleaner has completed a cleaning cycle. This is not an error. No action required.
10	Communication	a. Turn cleaner power off and on again to reset. b. Check floating cable connection to the control unit. Check for corrosion or bent pins at the connection point. c. If this does not resolve the problem, contact your local retailer for a diagnostic review or call customer service.
11	Sensor Unit	• Contact approved service station for replacement.
N/A	Connection Error	a. Check that the control unit is plugged into an approved power outlet and that the LAN/WEB icons on the box are illuminated. b. If not, go through the set-up steps to reconnect to the home router or press the Wi-Fi to Phone button to connect the system in 15-minute Wi-Fi to Phone mode. c. Check that the router is in close enough range to the control unit. Install a Wi-Fi extender if necessary.

8.2 General Troubleshooting

The following list provides some helpful hints for troubleshooting common challenges when using the cleaner.

User Issue	Possible Cause	Suggested Solution
Lights on control unit flash after pressing Start/Stop	Floating cable not connected	Unplug and then reconnect the floating cable to the control unit.
	Cleaner not fully submerged.	Remove cleaner from pool and re-submerge (see <i>Install and Submerge the Cleaner</i>).
	Poor connection or need to restart cycle.	Unplug the control unit and reconnect to an approved power outlet. Press "Start" to begin a new cycle.
	Propeller or wheels may be jammed and not turning correctly.	Contact your local retailer to request a diagnostic review. If the problem is not resolved, contact Zodiac Customer Care at 1300 763 021.
The flashing lights appear on the control unit during the cleaning cycle.	Cleaner not fully submerged	Remove cleaner from pool and re-submerge (see <i>Install and Submerge the Cleaner</i>).
The cleaner does not stay on the pool surface or is floating excessively.	There is air trapped inside the cleaner housing.	Remove cleaner from pool and re-submerge (see <i>Install and Submerge the Cleaner</i>).
	The filter canister is full or dirty.	Dispose of debris and thoroughly clean the filter canister with mild soap and a soft brush. Then, re-submerge the cleaner (see <i>Clean the Filter Canister</i>).
The cleaner is not climbing walls.	The filter canister is full or dirty.	Dispose of debris and thoroughly clean the filter canister with mild soap and a soft brush. Then, re-submerge the cleaner (see <i>Clean the Filter Canister</i>).
	Tyre treads worn down	See <i>Replacing Wear Parts</i>
	Confirm appropriate pool chemistry	Speak with your pool service professional. Do not leave cleaner in the pool during any chemical treatments.
The cleaner is not moving	Not connected to electricity.	The outlet the control unit is connected to, is not supplying electrical power. Check that the outlet to which the control unit is connected is receiving electricity.
	Cycle not started.	Press the Start button to initiate a cleaning cycle.
	Reset needed	Disconnect the unit power and reconnect after 20 seconds. If the problem is not resolved, contact your local retailer to request a diagnostic review or contact Zodiac Customer Care at 1300 763 021.
The floating cable has excessive tangling	Too much cable in the water.	Place only the required amount of cable into the water to allow it to reach the farthest end of your pool with remaining cable on the pool deck (see <i>Install and Submerge the Cleaner</i>)
	Removal needed	Untangle the twisted cord and lay in sun to reduce memory (see <i>Cord Tangling</i>).
The cleaner is not cleaning the pool effectively.	Filter canister is full or dirty.	Dispose of debris and thoroughly clean the filter canister with mild soap and a soft brush. Then, re-submerge the cleaner (see: <i>Clean the Filter Canister</i>).
	Brushes are worn.	Check the wear indicator(s). Contact your local dealer for spare parts.
	Cable is excessively tangled.	Untangle the twisted cord and lay in sun to reduce memory. (See: <i>Cord Tangling</i>).
Pool temperature reading from the cleaner (certain models only) is different to the temperature reading shown in the iAquaLink app or other equipment.	The cleaner reading is taken from the bottom of the pool. Deeper water will be colder than at the waterline.	Take an average of the two readings to approximate current pool water temperature.

8.3 Dismissing an Error Code

From the Control Unit:

After you have completed the troubleshooting solution steps, press any key (except the phone icon) to clear the error code.

If the control unit is in Standby Mode, press the Start/ Stop button to show the on-screen display. After you have completed the troubleshooting solution steps, press any key (except the phone icon) to clear the error code.

From the iAquaLink™ App:

Press the error icon to display troubleshooting solutions. After you have completed the troubleshooting solution steps, press **Clear Error** to return to normal operation. Or, press **OK** if you need to complete the solution steps at a later time.

8.4 iAquaLink Troubleshooting

This information can help to troubleshoot connection and setup challenges between the iAquaLink app and the cleaner.

How It Works

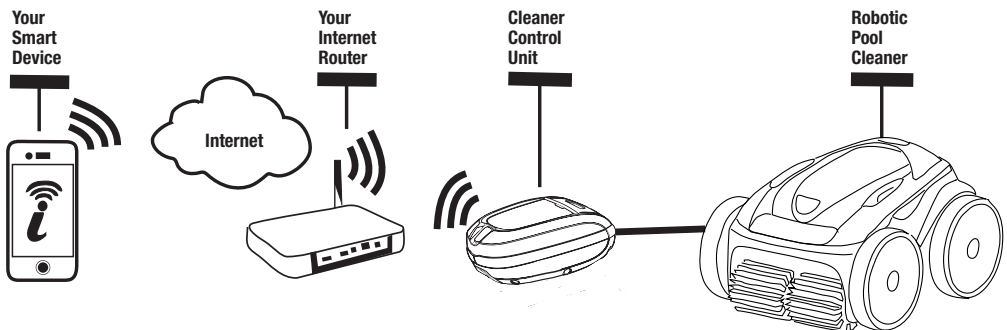

How to connect:

You must connect to the home router (network) by first establishing a direct connection between the control box and your smart device. (See: *Configuring the System*.)

IMPORTANT: It is recommended to locate the control box as close to the home router as practical. Do not use an extension cord.

8.5 Common iAquaLink™ Troubleshooting

Remember, if you get a new Wi-Fi Router, reset the defaults of your current Wi-Fi Router or simply change your Wi-Fi network password, you will have to re-establish the connection between your cleaner and the router. (See: *Configure the System.*)

User Issue	Possible Cause	Suggested Solution
All lights are off	Bright sunlight	Shield the lights to block sunlight and re-check if the lights are lit.
	Control box is unplugged.	Plug the control unit in. (See: <i>Connect to a Power Source.</i>)
	Power outage.	Verify that the breaker is on and electricity is being supplied to the outlet.
	Lost internet connection.	Check internet connection - Network may be down.
Wi-Fi is off	Router is off.	Turn router on.
	Router password was changed.	Reset router with new password.
Wi-Fi light is flashing	Lost internet connection	Check internet connection - Network may be down.
	Control box is too far from home router	Relocate the control box as near to the home router as practical. (See: <i>Install and Submerge the Cleaner</i>) Do not use an extension cord.
	Weak Wi-Fi signal	<ul style="list-style-type: none"> • Check for adequate Wi-Fi signal strength. • With a Windows laptop, go to Network Connections in the Control Panel. Check Signal Strength meter under Wireless Network Connection icon while standing near the control box. • With a smart device, search for, download, and use an app that can check signal strength while standing near the control box. If Wi-Fi signal is weak, consider installing a Wi-Fi extender.
	Connectivity issue with local Wi-Fi or connection to the server.	Contact your local internet service provider. <ul style="list-style-type: none"> • Unplug your control box and wait 10 seconds. Plug in the box again and see if lights illuminate. • Check Internet connection - Network may be down.
	Antenna firmware update in progress.	Flashing may continue up to ten minutes until update is complete.
Wi-Fi light is on but buttons and functions are disabled	Firmware update in progress	PROG displays on the control unit and information is displayed in the app during an over-the-air firmware update. Wait for button functions to resume after update is completed. Do not unplug from power during an update.

8.6 Conformity



IEC 60335-2-41



 Australian Cert. No.
GMA-514092-EA

Intertek

The manufacturer reserves the right to modify these specifications without notice. Although the cleaning robots have been tested in a large variety of swimming pools, Zodiac cannot be held responsible in the case of a non-perfect adaptation of the robot to a particular swimming pool.

NOTES

NOTES

<p style="text-align: center;">WARRANTY REGISTRATION</p> 	<p>For full warranty terms and conditions and to register your warranty, visit www.zodiac.com.au/warranty and complete your details.</p> <p>◀ Or scan the QR code to go directly to the registration page.</p> <p>Record your equipment details here for quick reference:</p> <p>Model No. : _____</p> <p>Serial No. : _____</p>
<p style="text-align: center;">WARRANTY REGISTRATION</p> 	<p>For full warranty terms and conditions and to register your warranty, visit www.zodiac.co.nz/warranty and complete your details.</p> <p>◀ Or scan the QR code to go directly to the registration page.</p> <p>Record your equipment details here for quick reference:</p> <p>Model No. : _____</p> <p>Serial No. : _____</p>

A Fluidra Brand | Zodiac.com.au | Zodiac.co.nz

Fluidra Group Australia Pty Ltd | 1 Herbert Place, Smithfield NSW 2164, PO Box 7238 Wetherill Park NSW 1851, Australia
 ABN: 87 002 641 965 | 1300 186 875

Fluidra NZ Ltd | 13 Douglas Alexander Parade | Rosedale Auckland 0632, New Zealand
 NZBN: 942 903 181 70759 | 0800 807 665